

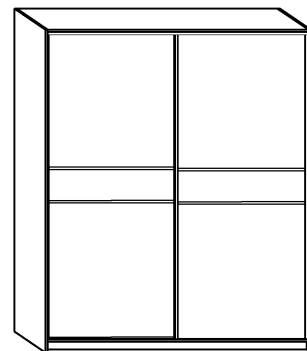











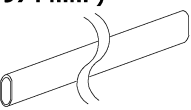

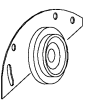

PUERTO 180B

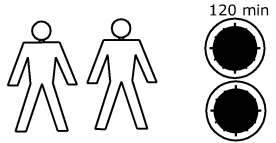
→ 180 ↑ 216 ↘ 65



x 28  (a)	x 15  (b)	x 2  (c)	x 2  (d)
x 2 (974 mm)  (e)	x 4  (f)	x 6  (g)	x 2  (h)
x 4  (j)	x 4  (k)	x 4  (l)	
x 40 (3,5 x 13)  (m)	x 8 (6,2 x 13)  (n)	x 130  (o)	x 1  (p)

1 - FAZY MONTAŻU

A - OZNACZENIE ELEMENTÓW

a - OZNACZENIE AKCESORIÓW

1

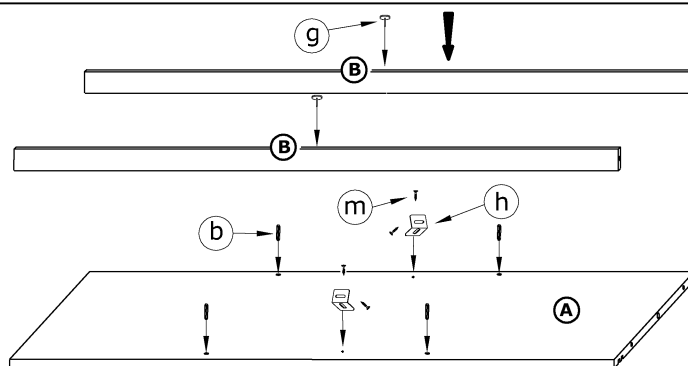

2

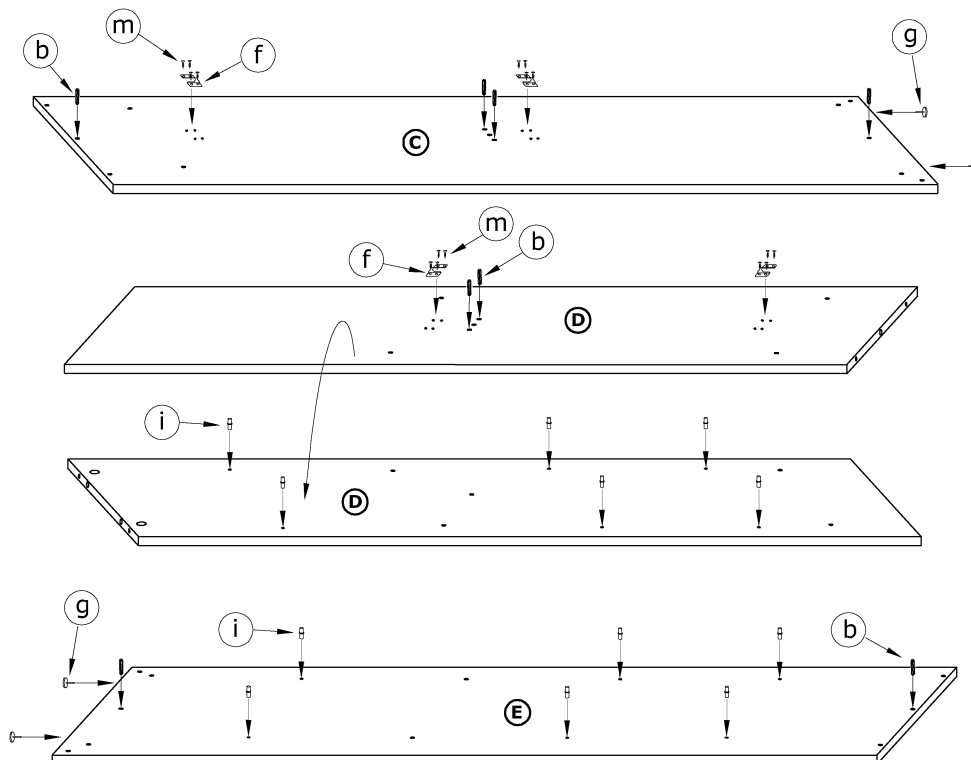

3

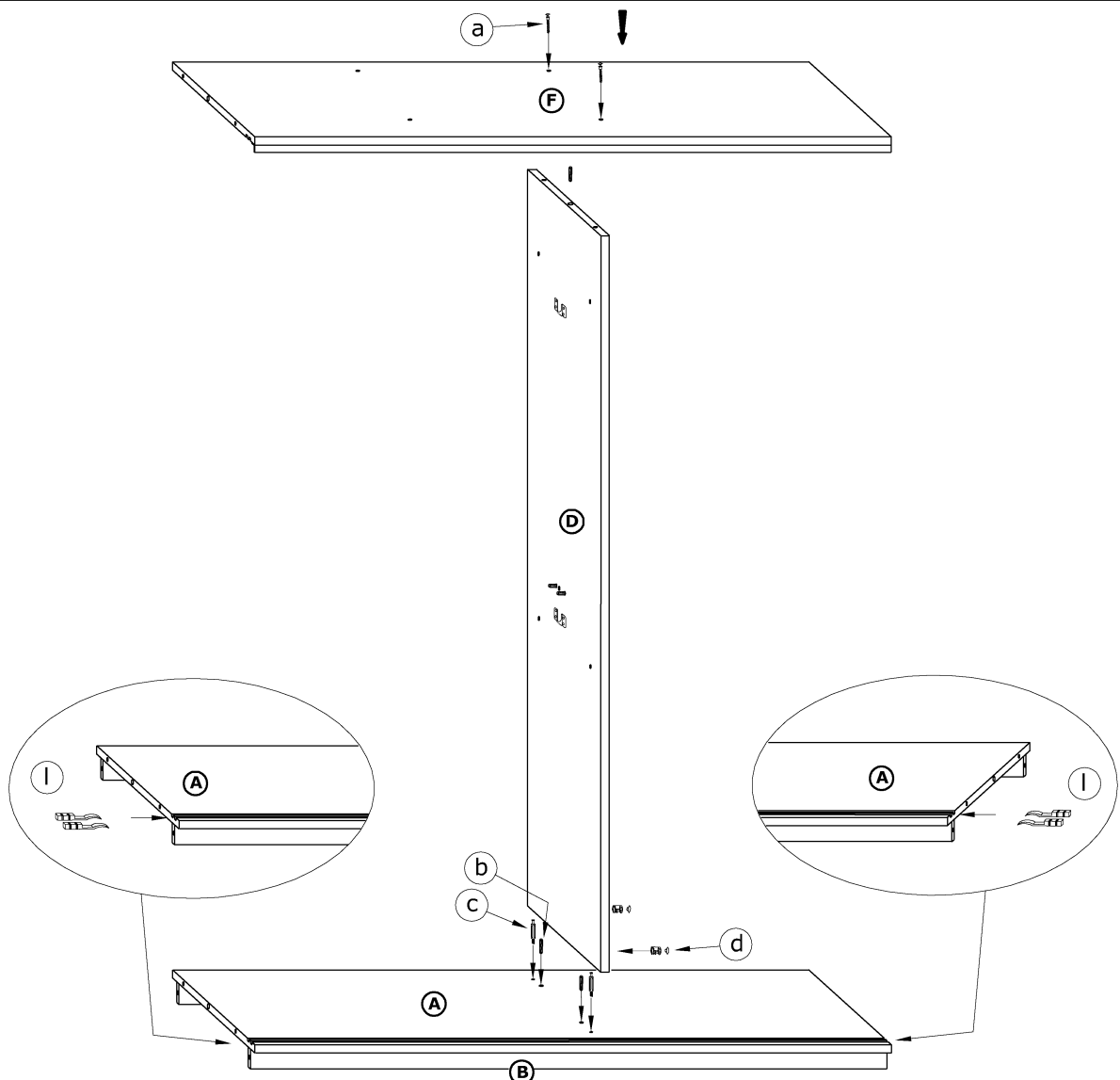

4

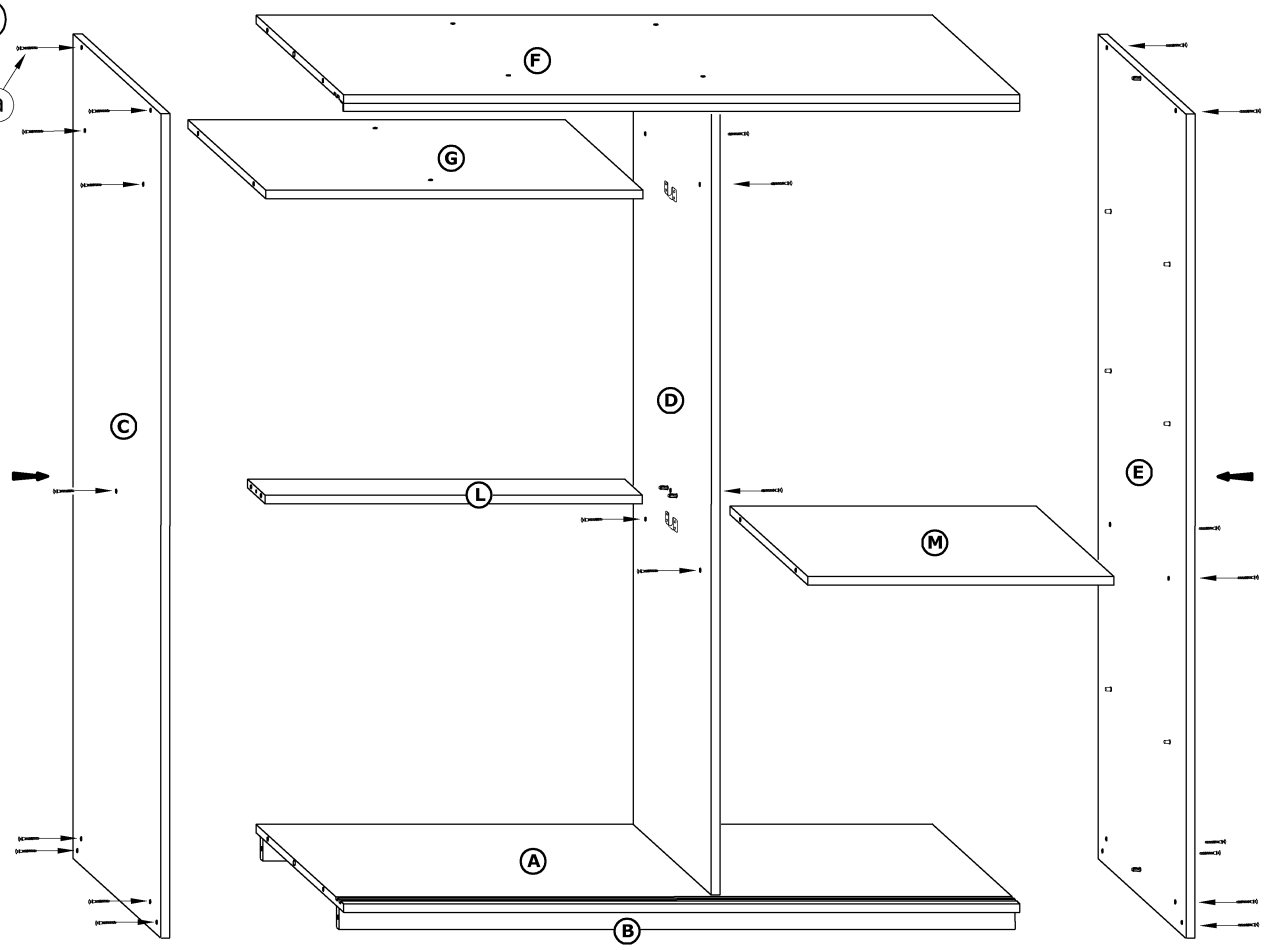

5

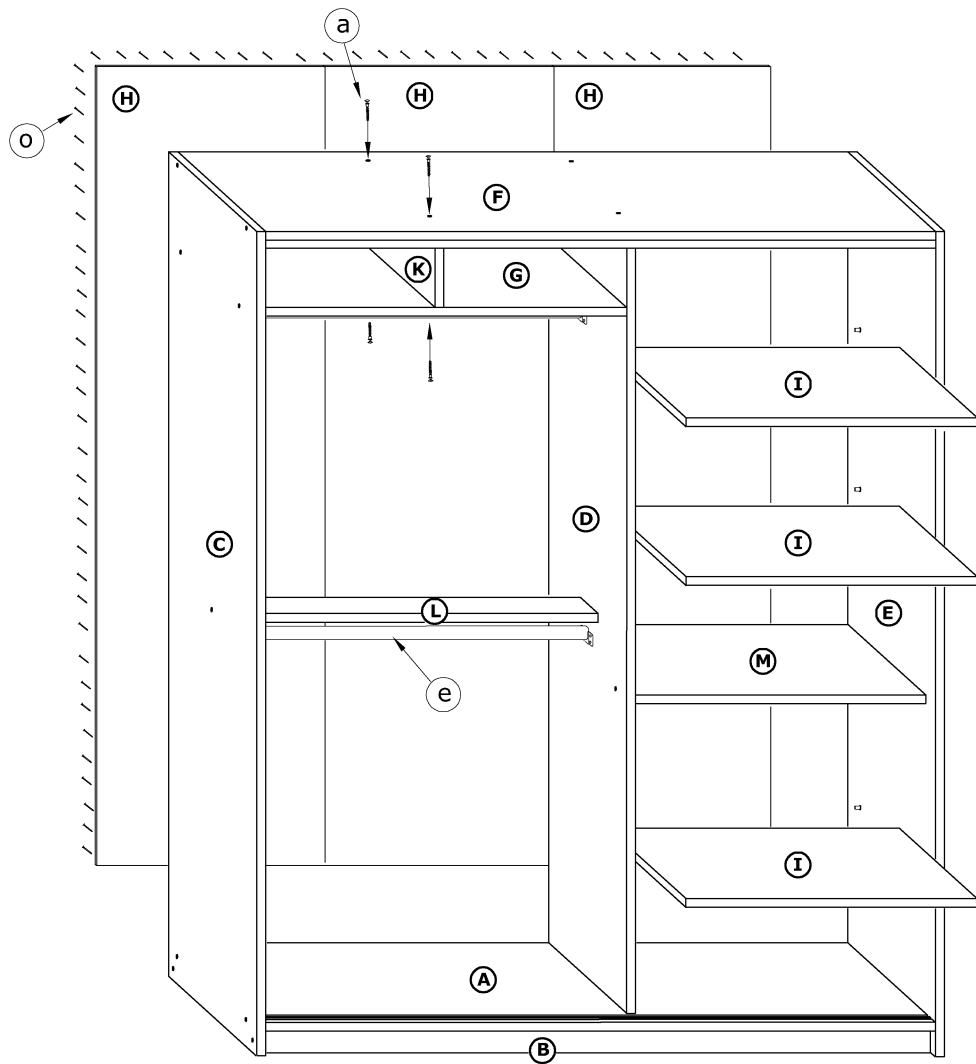

6

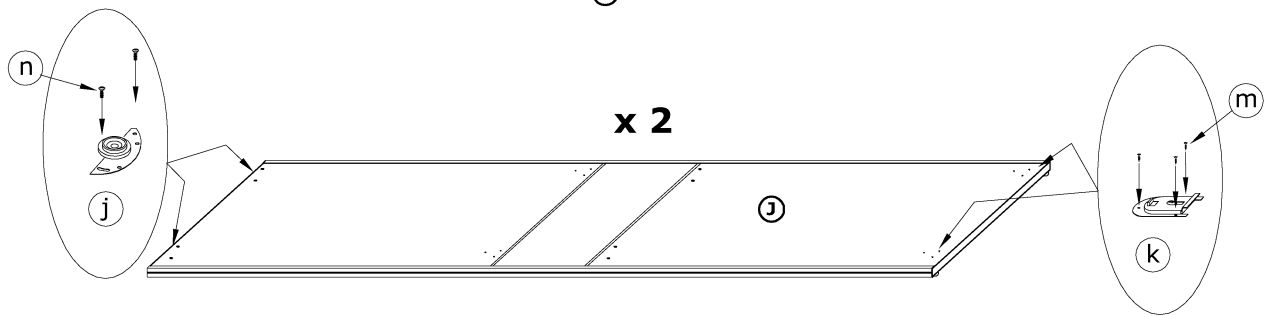

7

